

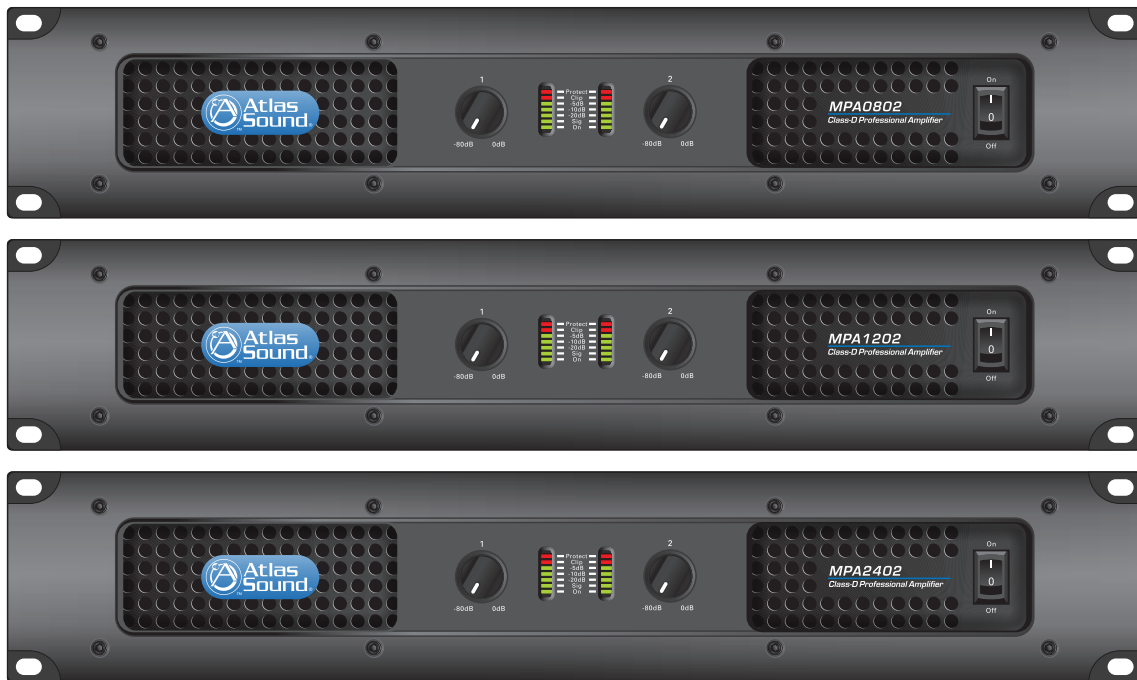

MPA Series Class-D Professional Amplifiers MPA系列功率放大器



1601 Jack Mckay Blvd, Ennis, Texas 75119, USA
Telephone: 800.876.3333 • Fax: 800.765.3435



目录表

重要安全事项和符号说明.....	3
前言.....	4
前板功能介绍.....	5
后板功能介绍.....	6
系统连接实例.....	7
功放安装配电配线.....	8
功放散热条件.....	9
功放使用电平的调整.....	10
技术指标.....	11
故障排除.....	12
产品物质拆分表.....	13





重要安全事项和符号说明

1. 阅读这些规定。
2. 保存好这本使用手册。
3. 注意所有警告。
4. 遵守这些规定。
5. 可使用软布及风枪进行清洁。
6. 要注意不要形成热风循环。按建议方法进行安装。
7. 不要安装在热源附近，尽可能保证环境气温在35°C以下使用。
8. 确保接地良好，不建议浮地使用。
9. 保护电线防止被踩踏或挤压，尤其要注意插头、电源插座及其连接设备处。
10. 必须按照以下开关次序来使用该产品：前级-功放（开）、功放（关）-前级。
11. 通电前必须确保供电电压符合该设备的要求。
12. 若输入信号并接超过三台功放，建议使用信号分配器，以确保输入信号不至失真。
13. 不要将功放的某一个声道的输出接口接到另一个通道的输入接口。不要将功放的输出并联或串联到另一台功放的输出接口来使用。
14. 设计系统配置功放的时候，功放的功率应比音箱在相同阻抗的标称功率大50%-100%，应小心使用桥接模式。
15. 在维修功放的时候，禁止在桥接状态下将示波器的探头连接到功放的输出端，以免损坏功放和示波器。
16. 建议：1) 由于输出到音箱的电流较大，建议使用质量有保证的NL4型音箱螺旋插头。
2) 多台功放使用时应计算好合适的配电，以确保达到合格的使用环境。



提醒用户本手册中有重要的信息。



小心触电，非拥有相关资质的人员请勿擅自开盖维修。

警告

为避免着火或电击，不要将设备暴露在雨中或潮湿的环境中。



1601 Jack Mckay Blvd, Ennis, Texas 75119, USA
Telephone: 800.876.3333 • Fax: 800.765.3435



前言

欢迎

非常感谢您购买本公司产品，MPA系列专业功放，操作简单、工作稳定、性价比高，用途广泛。专为卡拉OK包房、语言扩声、中小型演出、演讲等场合使用。为了更好的发挥产品性能，请在使用前仔细阅读本手册。

拆包

请在拆开包装后，确认功放的外观没有在运输途中遭到损坏。确认功放的预设电压和你所在地的交流电压额定值匹配（详细信息见功放背板印刷）建议您保留包装箱，以便在需要退还产品时使用。

重要的安全注意事项

本公司的产品设计已经考虑到安全使用的要求，并遵照相关的国家的安全规定检验出厂产品，只有合格的产品才能出厂销售。但由于本产品内部有危险高压和电量，因此要求用户必须认真阅读本手册的注意事项。如果产品跌落、凹入、浸湿或者里面有部件松动，则会大大增加人被电击的危险。当发生以上问题时，请马上切断电源，然后将本产品送还指定的经销商进行检查维修！

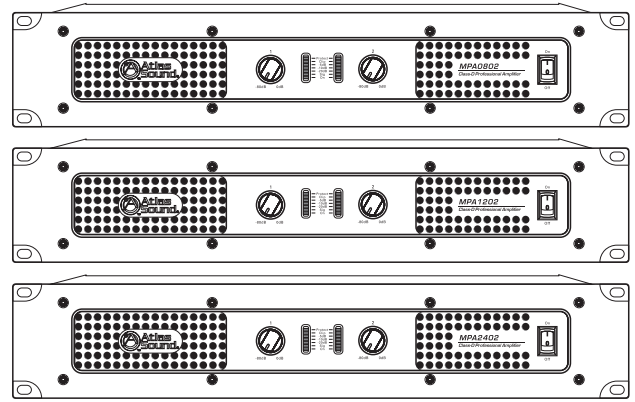



前面板功能介绍

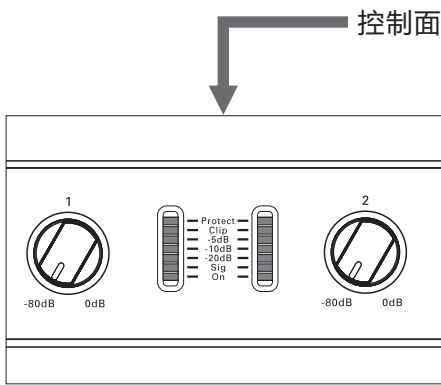
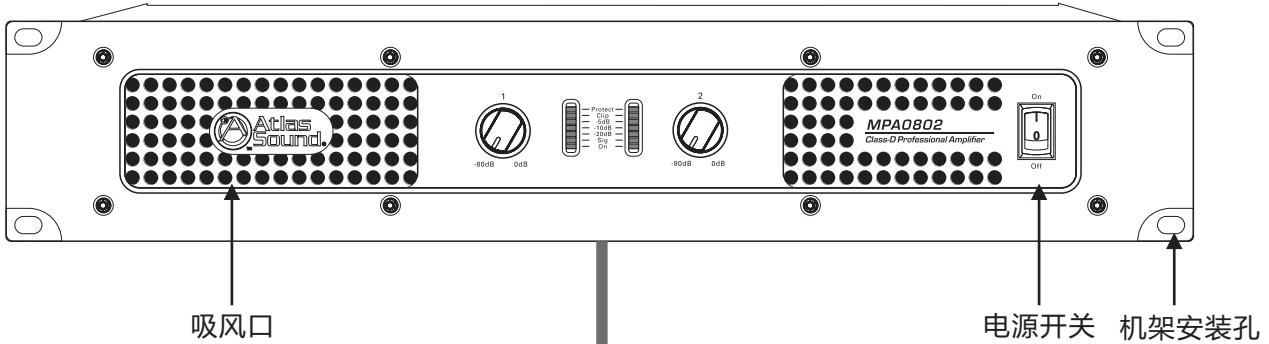

- Protect → 任何一种保护电路动作时亮起
- Clip → 削峰/失真压限电路动作时亮起
- 5dB → 输出信号幅度距满功率约为-5dB
- 10dB → 输出信号幅度距满功率约为-10dB
- 20dB → 输出信号幅度距满功率约为-20dB
- Sig → 信号指示灯
- ON → 开机后亮起
- CH1-CH2 → 增益控制器旋钮 (调音量)
300°音量旋钮0/-80dB。
立体声/并接:CH1与CH2音量独立控制。
桥接模式:CH1同时控制两通道音量衰减
CH2音量控制失效。
对于正常使用,将控制器保持在最大(0dB)。

滤尘网清洁操作指引



在工程建设完成时,应对滤网进行首次清洁。
在往后的时间,应根据实际的情况,建议每季度定期进行清洁一次。

不允许拆除该滤网继续使用本产品,否则将影响本机的使用寿命。

在此情况下产生的故障,将被认定为脱保!

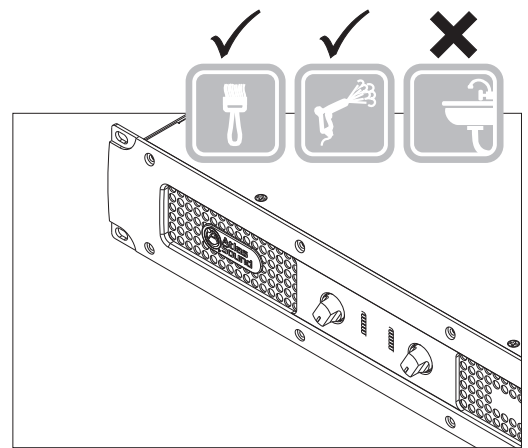

1601 Jack Mckay Blvd, Ennis, Texas 75119, USA
Telephone: 800.876.3333 • Fax: 800.765.3435



后板功能介绍

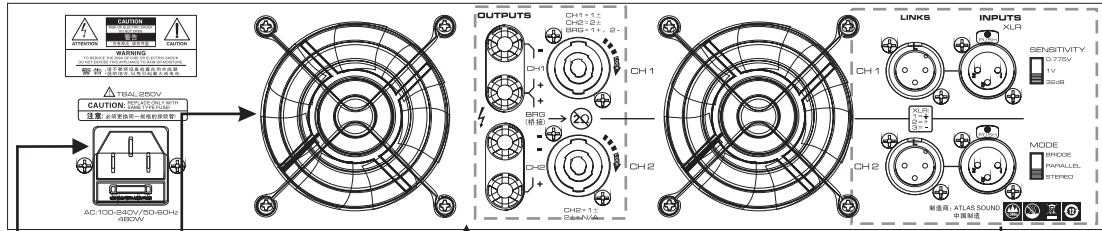

电源插座

排风扇

功率输出端

信号连接端

音箱连接端

信号线连接端

! 双通道模式下可工作在2~16欧
桥接模式下可工作在4~16欧

! 不建议桥接4欧长期使用，
这可能导致功放使用寿命
缩短或者产生故障！

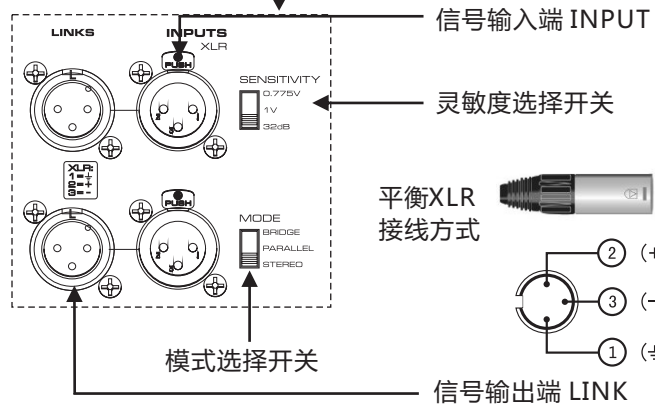

信号输入端 INPUT

灵敏度选择开关

平衡XLR
接线方式

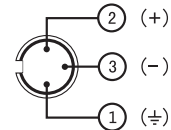

模式选择开关

信号输出端 LINK

! 焊接质量很重要！
虚焊或是焊接错误，
将可能影响到正常使用，
甚至产生故障。

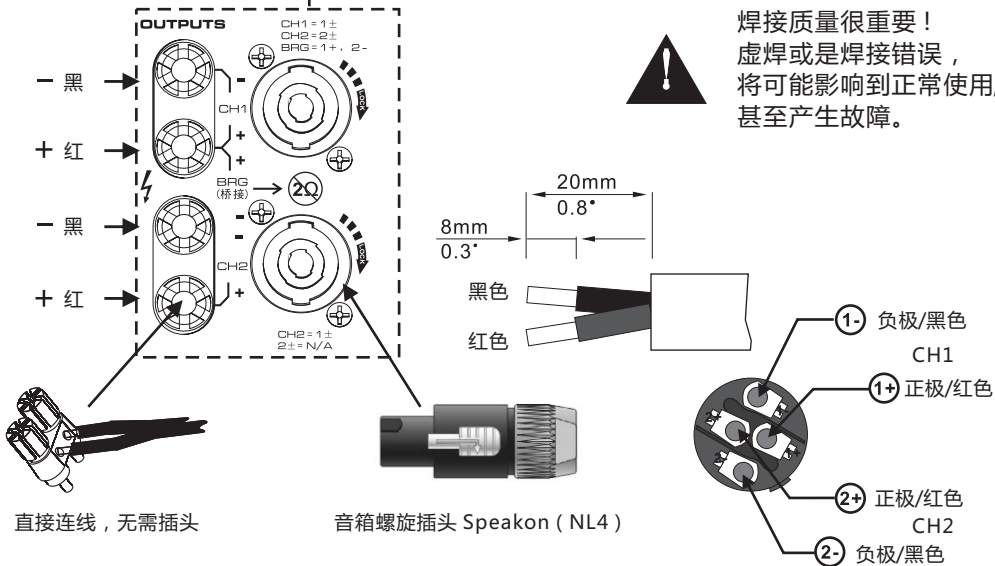

直接连线，无需插头

音箱螺旋插头 Speakon (NL4)



1601 Jack Mckay Blvd, Ennis, Texas 75119, USA
Telephone: 800.876.3333 • Fax: 800.765.3435



系统连接实例

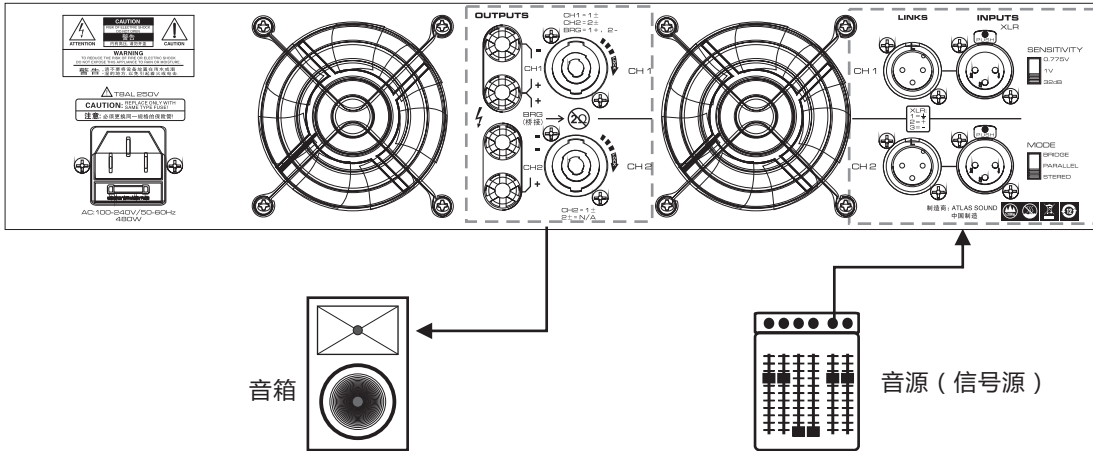

桥接模式

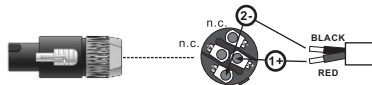
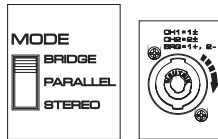

或

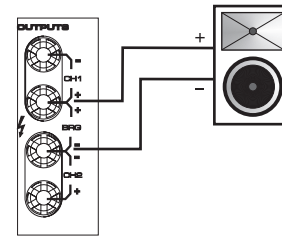

注：CH1输入有效。

并接模式

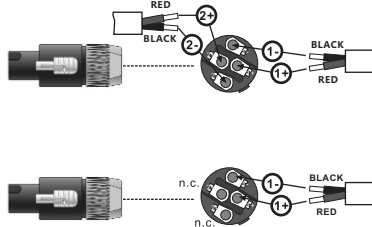
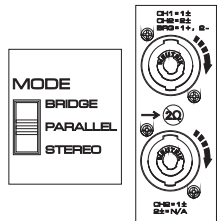

或

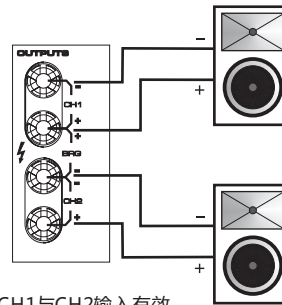

注：CH1与CH2输入有效。

立体声模式

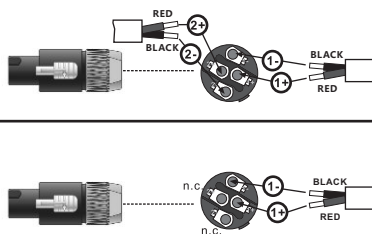
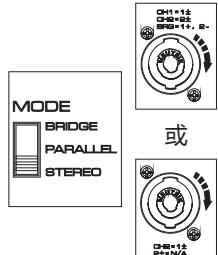

或

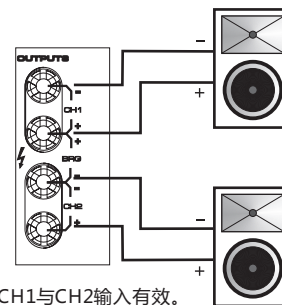

注：CH1与CH2输入有效。



1601 Jack Mckay Blvd, Ennis, Texas 75119, USA
Telephone: 800.876.3333 • Fax: 800.765.3435



功放安装配电配线

配线配电

放大器的电源供应作为一个非阻性负载，所以计算“伏特x安培=瓦”不会是正确的，同时因为其应用在非稳定输出的音乐波形信号上，所以其实际的耗电量不能以固定的公式进行计算。

参考不同型号产品的耗散功率与供电/AC进行配线
建议用户搭配不低于以下的配线径规格，以获得更佳的综合性能。

标配电压：100-240V

型号	耗散功率	配线径规格
MPA0802	480W	$\geq 1.5\text{mm}^2$
MPA1202	800W	$\geq 1.5\text{mm}^2$
MPA2402	1100W	$\geq 1.5\text{mm}^2$

当多台使用同一电源插板时，其供电电缆截面应根据总需求作出相应的增加，而插板内部线缆也需要确认能满足电力的需求。



后板标示的电源电压(例：220V/240V必须在AC200~240V之间的)范围内。并且应尽可能令其稳定。根据不同的供电电压，产品的输出功率会随电源电压高低变化而变化。

多台安装

当在同一电力供应的条件下，其总配电功率超过10kW时，建议采用三相配电。须使用三相五线制，禁止有零线与地线共用的情况。

通电检查



首次通电必须用万用表测量电源电压，并确认是否符合产品的要求条件。
在首次通电时，请不要连接信号线和音箱线，您只需作简单的通电检查，确认其正常后请将电源关闭。

安全地线之重要性



产品应用上建议您必须接地，以策安全。

若您没有及格的地线或不接地时，当人体接触产品其外壳，可能会感到有电击之感，甚至感到不安。为避免此种情况的出现，请务必使用合格的地线将产品接地。



功放的散热条件

堆叠安装

为保障散热环境，请安装产品时满足以下条件

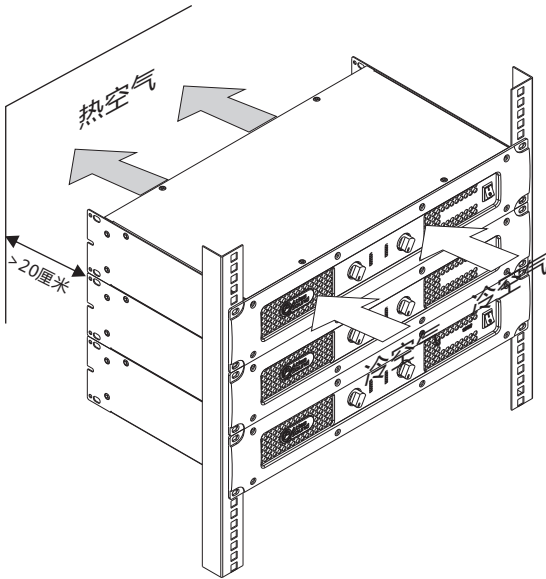

在工程竣工前，因为建造环境灰尘很多，而调试期间就会有大量灰尘积聚在滤尘海绵中，令风路不畅，造成故障隐患。

若出现此情况，建议采用大功率吸尘器直接清洁滤尘海绵，而且要每月做一次维护从而保证其散热良好。

输入/输出接驳线缆不可堆叠在产品排风扇口，请置于功放两侧捆扎好！



环境气温应 $< 35^{\circ}\text{C}$ 下工作

风短路的避免

防止排出的热风回送至前面吸风口。

安装强排设备
强制将热空气带走

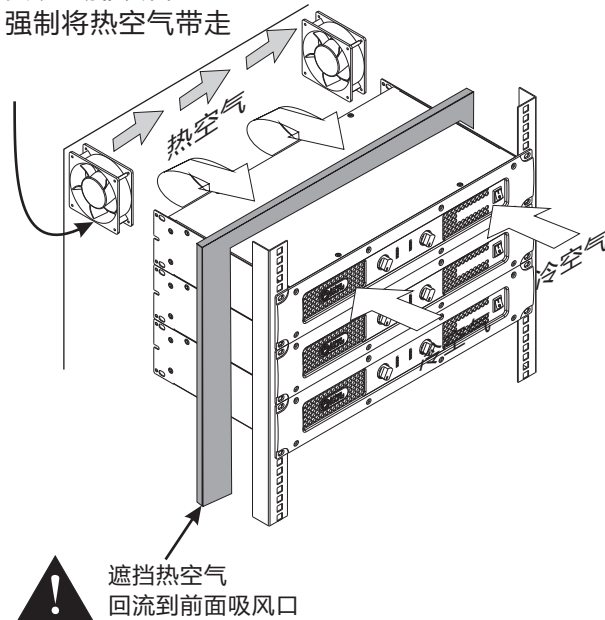

遮挡热空气
回流到前面吸风口



非水平堆叠时，建议机尾排风口向上或直向排风口



在工程调试时验证机柜内气温，在极限条件下，也应保持在 35°C 以下。



1601 Jack Mckay Blvd, Ennis, Texas 75119, USA
Telephone: 800.876.3333 • Fax: 800.765.3435



功放使用电平的调整

开、关机步骤

开机

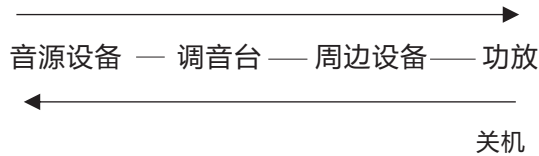

系统电平调整

以下调整过程，功放应处于空载的状态

流程：

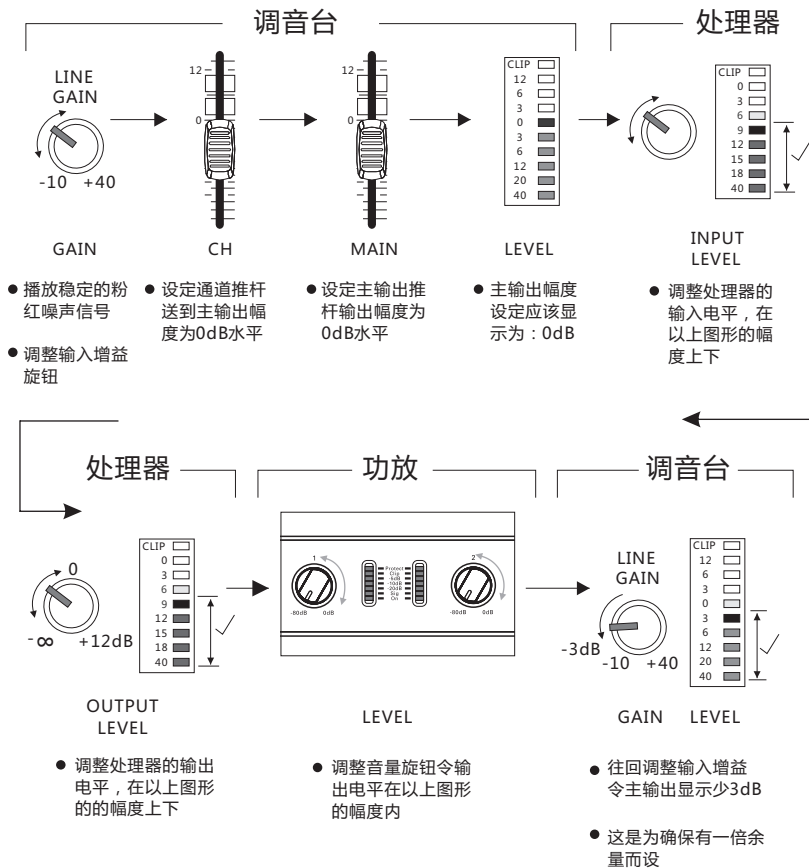

对于大功率系统，次序尤为重要，不按该顺序将有可能损坏器材。为此建议您采用电源管理器来管理。



该调试流程为常规过程，为了更准确地调整系统，应聘请专业工程师来进行该项操作。

带载试听

从较小音量位置开始调整音量旋钮，在证明音箱发出正常的音乐后，方进一步将音量开大。在音箱声压输出接近饱和时（注意此高声压当中的风险），功放的电平指示灯应该在CLIP灯亮起之前，并确保CLIP灯不能频繁亮起。



该步骤必须请有经验的专业人士操作，未有十足之把握敬请小心操作！





技术指标

型号	MPA0802	MPA1202	MPA2402
功率			
8Ω立体声功率	300Wx2*	500Wx2*	700Wx2*
4Ω立体声功率	500Wx2**	850Wx2**	1250Wx2**
2Ω立体声功率	750Wx2**	1250Wx2**	1600Wx2**
8Ω桥接功率	1000W**	1700W**	2500W**
4Ω桥接功率	1500W**	2500W**	3200W**

其他参数

频率响应	20Hz-20KHz(+0/-1dB)		
总谐波失真	≤0.09%	≤0.09%	≤0.09%
信噪比	≥100dB	≥100dB	≥100dB
阻尼系数	≥500	≥500	≥500
转换速率	≥10V/μs	≥10V/μs	≥10V/μs
输入灵敏度	0.775/1.0V/32dB		
输入阻抗(平衡/不平衡)	20kΩ/10kΩ		
电压增益	36dB	38.2dB	39.7dB
输出类别	Class D	Class D	Class D
冷却	从前到后抽风		
保护功能	超压保护、RF、VHF、软启动、直流、短路、过载、削峰/失真压限、过热、开机音量渐大		

连接器

输入部分	平衡输入XLR母插座/平衡并接XLR公插座
输出部分	BINDING POST (红黑柱) /SPEAKON (音箱螺旋座)

使用功能

面板功能	电源开关/音量控制旋钮/电源指示/信号指示/-5dB/-10dB/-20dB/削峰压限指示/保护指示/超温保护
后板功能	立体声\并接\桥接选择开关、灵敏度选择开关

尺寸和重量

产品外形尺寸(Wx Lx H) (mm)	483x305.5x89	483x305.5x89	483x305.5x89
外包装尺寸(Wx Lx H) (mm)	560x420x170	560x420x170	560x420x170
毛重	7.8kg	8.1kg	8.5kg
电源	13A电源线		

注意：1. *此功率是使用40ms脉冲1kHz正弦波在1%总谐波失真下测量得出；
2. **此功率是使用20ms脉冲1kHz正弦波在1%总谐波失真下测量得出。



1601 Jack Mckay Blvd, Ennis, Texas 75119, USA
Telephone: 800.876.3333 • Fax: 800.765.3435



故障排除

通电后，无任何反应

马上用万用表测量插座是否有电，在没有万用表时可用试电笔，但必须灯泡显示明亮，否则可怀疑电压不正常。若插座电压正常，供电无怀疑后，通电的功放仍然无任何反应，则可判断该功放有故障，需要专业人员进行进一步故障判断。

功放无声音输出

1、首先判断输入的信号是否正确

▲ 卡侬XLR的2/3脚有无反接的可能，地屏蔽线是否连接可靠。根据输入线路的设计不同，可能在以上有些产品会表现正常，而有些则无声，请务必按照2+、3-的方式连接。不可以采用比对其他功放（包括同厂产品）的方式判断。

2、面板指示信号灯不亮

排除信号线问题后，若功放无输入信号反映，可判断功放本身可能存在故障，需专业人员进行进一步故障判断。

3、输入信号正常但仍无声

正面的信号指示灯是否有闪动和根据音量大小而跳跃，若正常，而无声音输出，立即检查连接的NL4插头是否连接正确（±1，±2的连接问题）是否连接牢靠。若以上都无问题，仍然无声，可以尝试其它通道观察是否有相同的现象。若还是一样，请立即更换另一个NL4插头再作连接尝试。

▲ 根据经验，可能有某些插头和该产品的插座接触不良导致的。

功放输出声音失真

1、失真表现为小声音已经很明显能听出声音有破裂声在排除信号本身和音箱的问题后，可判断为该功放可能存在故障。需专业人员进行进一步故障判断。

2、某个频段失真

首先判断音箱本身是否能承受该功放的输出功率，一般在95~105分贝时判断，再大的音量输出不作评论。本篇幅只讨论功放自身问题的排除。若是在中频段声音有轻微破裂尾音，并且在音量越小时表现为越明显，可判断为功放可能有交越失真，此失真声音比较容易和音箱本身高频激励器故障混淆，请做出判断前最好再连接其它判断为正常性能的音箱比较测试一下。

3、大声压时失真

在小声压时表现正常的情况下，首先判断音箱对所播放音乐信号的大动态时的承受能力。请在合适的音量下聆听判断，若功放削峰指示灯（CLIP）时常亮起，请再降低音量后判断。音箱和功放都有适用的范围，请在所能接受的范围内使用，在超大音量下失真则可能功放及音箱都已经进入饱和状况，请适当降低音量使用。

功放保护指示灯（PROT）点亮

此指示灯点亮表明功放进入保护状态。形势不妙！

1、可能是温度过高、有高于4K的连续正弦波输出超过1秒、输出短路或接近短路等。以上情况可恢复的。并非故障。等恢复后可继续使用。但过热会等待较长时间才可恢复。并且出现过热时就必须检查产品的风扇是否运作正常，空间温度是否过高等，须排除问题后才可继续运作。若怀疑音箱短路，可以用万用表测量音箱线两端直流电阻是否低于2欧甚至1欧。（因电阻较小，为保证测试精度，请校准万用表后再测量）

2、此灯常亮，不可恢复

此类情况一般为功放本身故障导致，请联系维修人员跟进。

有交流声（哼声或称之为电流声）

1、功放不插入任何信号就有交流声

请将功放搬离于系统电源地线隔离的位置继续测试，只连接火零N/L，不连接地线。若输出还是有交流声，可判断为产品本身有问题，请与维修人员联系。

2、连接系统后有交流声

此现象为系统各单元设备的地电位不同而产生的。多数出现在供电为三相电时，各设备连接不同的相线，甚至不同上庄电源，零线带电导致，并非功放故障。

解决办法超出本说明书叙述范围，这里附赠解决经验，仅供参考，本厂不对此叙述负责！

A、梳理用电，尽可能使用同一配电箱的电源。

B、在必须接地的情况下，将不同的接地点强迫接为一点，在此动作前，请判断地线电位必须为零，若地线本身带电，则表明地线可能与零线相连。请先解决此问题。

C、我们不建议浮地使用设备。

以下情况表示放大器需要维修

- 1.产品冒烟或者发出严重烧焦味而不能使用时
- 2.机箱严重凹陷或者变形
- 3.产品浸入液体中
- 4.内部部件松动
- 5.加电时交流断路器自动跳开或保险管熔断





产品物质拆分表

为满足中国《电子信息产品污染控制管理办法》（信息产业部第39号令）的相关规定和要求，现对产品中有害物质，按部件分类，声明如下：

部件名称	有毒有害物质或元素					
	铅 (Pb)	汞 (Hg)	镉 (Cd)	六价铬 (Cr(VI))	多溴联苯 (PBB)	多溴二苯醚 (PBED)
机箱	×	○	○	○	○	○
主板模块	×	○	○	○	×	×
电源模块	×	○	○	○	×	×
I/O板模块	×	○	○	○	×	×
控制模块	×	○	○	○	×	×
灯板	×	○	○	○	×	×

备注：

○：表示该有害物质在该部件所有均质材料中的含量均在SJ/T11363-2006规定的限量要求下
 ×：表示该有害物质至少在该部件的某一均质材料中的含量超出SJ/T11363-2006规定的限量要求。

在中华人民共和国境内销售的电子信息产品上将贴上有“环保使用期限”（EPuP）符号。圆圈中的数字代表产品的正常环保使用年限。

图示：



Table of contents

Important Safety Instruction and symbol description.....	14
Foreword.....	15
Front panel functions.....	16
Rear panel functions.....	17
System connection cases.....	18
Wiring and AC power supply.....	19
Thermal Dissipation.....	20
Power Level adjustment.....	21
Specifications.....	22
Troubleshooting.....	23





Important Safety Instruction and symbol description

1. Read these instructions.
2. Keep this user manual.
3. Pay attention to all the notice.
4. Comply with these instructions.
5. Clean with soft cloth, or blow with hyperbaric air.
6. Warning: Avoid the formation of hot air circulation. Installation as suggested way.
7. Do not install near heat, make sure the application temperature is below 35°C.
8. Ensure that the grounding is valid, floating ground is not recommended.
9. Protect the wire from being trampled or extruded, especially the plug, socket and the connector of it.
10. Make sure the startup and turnoff procedure: Pre-amp - Amplifier (Power on) Power amplifier (off) -Pre-amp.
11. Power supply voltage must be in accord with the requirement of the equipment before use it.
12. Signal distributor is advised to be used when the input signal paralleled with more than 3 amplifiers, to ensure the input signal without distortion.
13. Don't connect the output interface of one channel to the input interface of another channel in the power amplifier. Don't connect one power amplifier to another one by connecting their output in series or parallel connection.
14. When equip the audio equipments, the power of the power amplifier should be 50%-100% more than the loudspeaker power. Be careful when in bridged mode.
15. When maintenance, don't connect the probe of the oscilloscope to the output interface under bridge mode in case of damaging the power amplifier and the oscilloscope.
16. Suggestions:
 - 1) Good quality NI4 Speakers screw plug is advised.
 - 2) Power distribution system should ensure the safety of applications of more than one amplifier.



The exclamation point triangle is used to alert the user to important operating or maintenance instructions.



The lightning bolt triangle is used to alert the user to the risk of electric shock. non-professional qualified technicians do not open TOP OR BOTTOM COVERS for maintenance

 **WARNING**
TO REDUCE THE RISK OF FIRE OR ELECTRIC SHOCK, DO NOT EXPOSE THIS APPARATUS TO RAIN OR MOISTURE.



1601 Jack Mckay Blvd, Ennis, Texas 75119, USA
Telephone: 800.876.3333 • Fax: 800.765.3435



Foreword

Welcome

Thank you for purchasing our products. The MPA series professional power amplifier, simple to operate, stable, high performance-cost rate. Special design for KARAOK ROOM, sound reinforcement, small performances, lectures and other places. Please take the time to study this manual so that you can obtain the best possible service from your amplifier.

Unpacking

Please unpack and inspect your amplifier for any damage that may have occurred during transit. Confirm the preset voltage of the power amplifier matches your local voltage rating (Please refer to the print on the rear panel for detailed information). We also recommend that you save all packing materials so you will have them when need to return the power amplifier.

Important safety precautions

Our products has already taken the safe requirement in to consideration and all the finished products have been tested under the requirement of the government before sale. Due to the inner dangerous high voltage and electricity, we strongly recommend you read all instructions, warnings and cautions contained in this manual. It will increase the chance of getting shock by the electricity if the product falls down, recess in the appearance, soaked or there were some parts loose internal. If there are problems above, please turn off power immediately and send the defective units to local distributor for service.

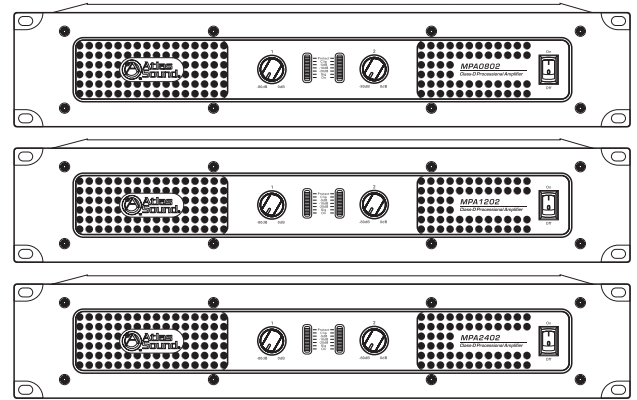



Front panel functions

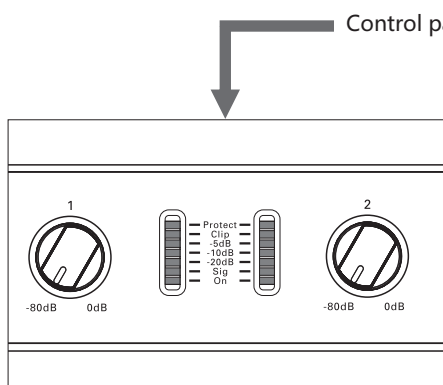
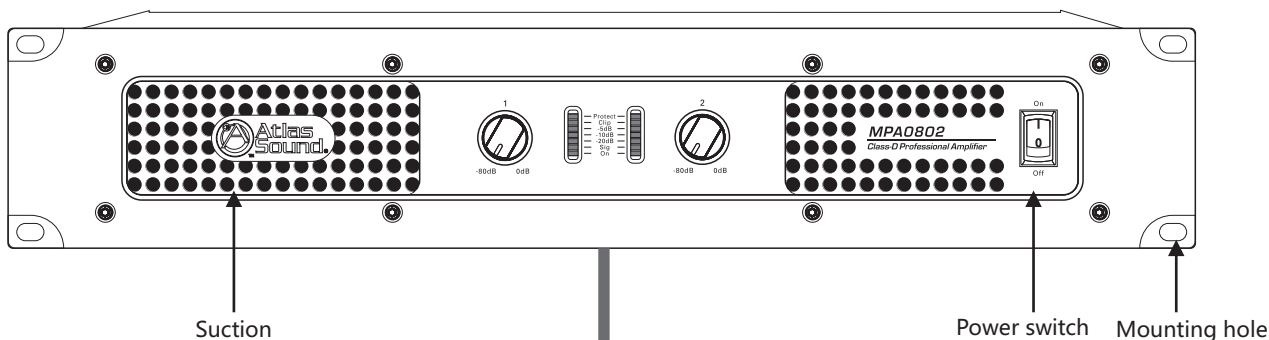

- Protect → Illuminates when either protection circuit action.
- Clip → Illuminates when compressor / limiter is protecting the amplifier from input overload.
- 5dB → Illuminates when output signal around -5dB than full power.
- 10dB → Illuminates when output signal around -10dB than full power.
- 20dB → Illuminates when output signal around -20dB than full power.
- Sig → The signal light
- ON → Illuminates when the amplifier start.

CH1-CH2 → Gain Controller Knob
 300° volume knob from 0 to -80dB.
 Stereo/Paralle Mode: volumes of CH1 and CH2 control independently.
 Bridge Mode: CH1 knob controls both volumes.
 Ch1 stops working.
 For normal operation, please keep the controller at max (0 db).

Cleaning guide of the dust filter



The first time cleaning of the strainer mesh should be right after installation. Recommend to clean the strainer mesh quarterly.

Please do not run the product without the dust filter, or it makes the service life of the product shorten.

Such condition will be considered as no warranty.

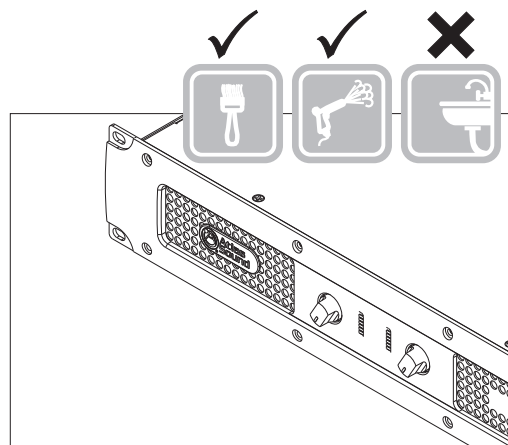

1601 Jack Mckay Blvd, Ennis, Texas 75119, USA
 Telephone: 800.876.3333 • Fax: 800.765.3435



Rear panel functions

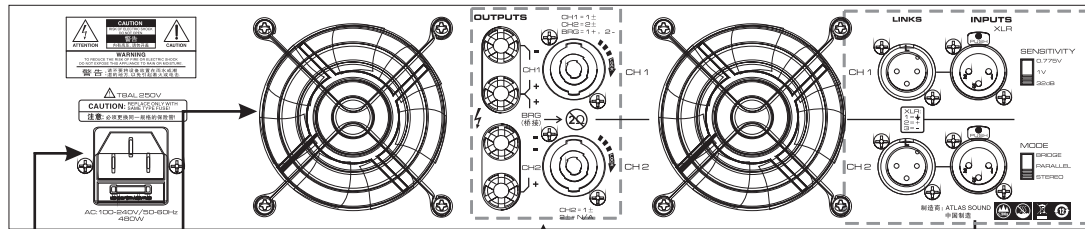

Circuit breaker FAN

Amp output

Signal connector

The speaker connector



It can work from 2-16ohm in stereo or parallel mode. It can work good from 4ohm to 16ohm In bridge mode



We don't suggest you use the amplifier under 4ohm bridge mode for a long time, it will short its normal use life or have some unnecessary failure.

Signal connection

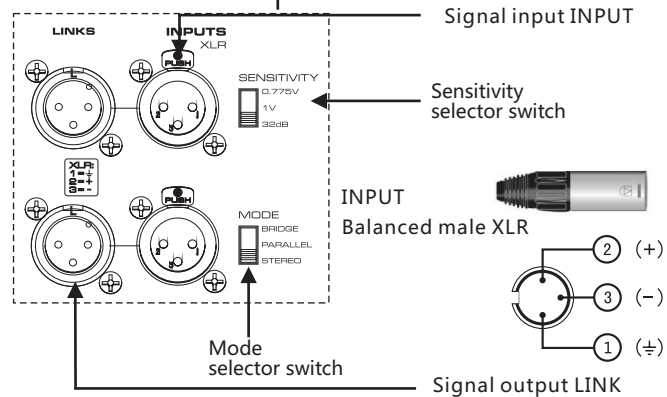

The quality of your soldering is very important. Virtual welding or soldering errors, would be likely to affect the normal use or even failure.

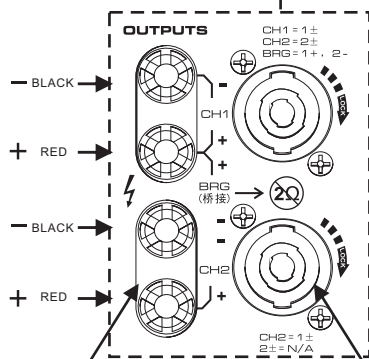

Direct connection without plug

Speakon (NL4)

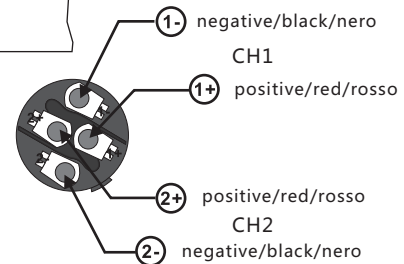
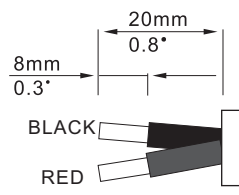

1601 Jack Mckay Blvd, Ennis, Texas 75119, USA
Telephone: 800.876.3333 • Fax: 800.765.3435



System connection cases

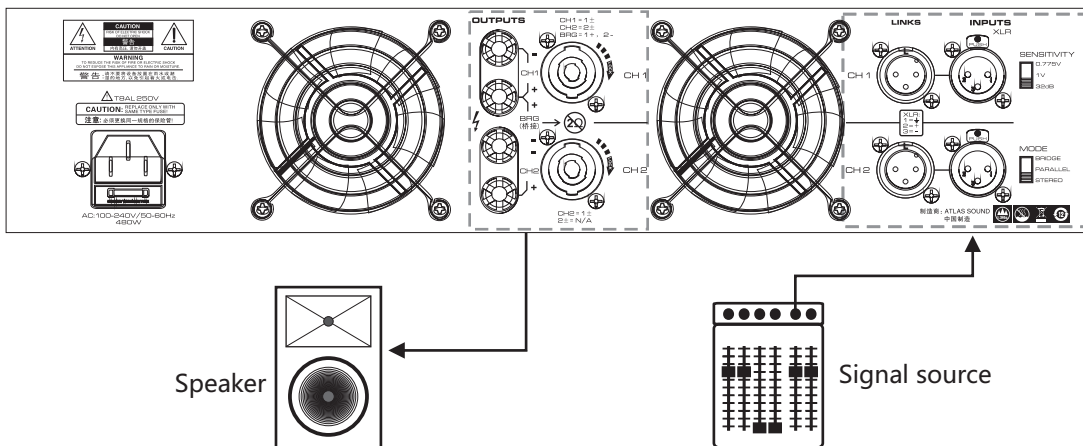

Bridge mode

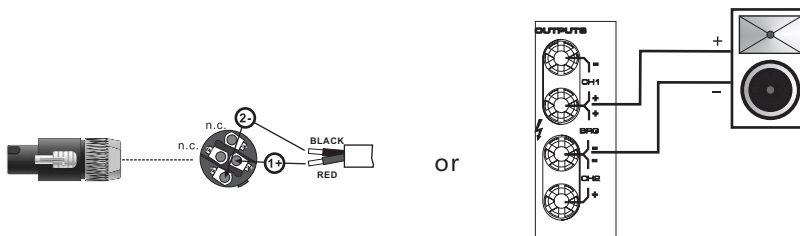
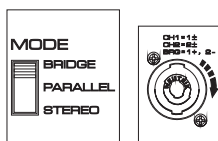

Remark : Inputs from CH1 is effective.

Parallel mode

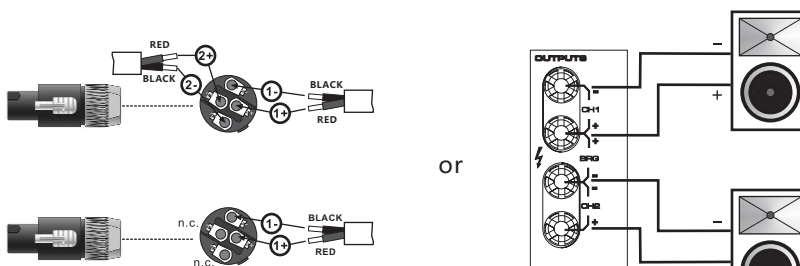
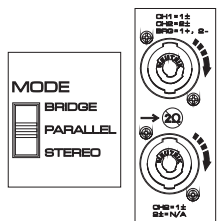

Remark : Inputs from CH1 is effective.

Stereo mode

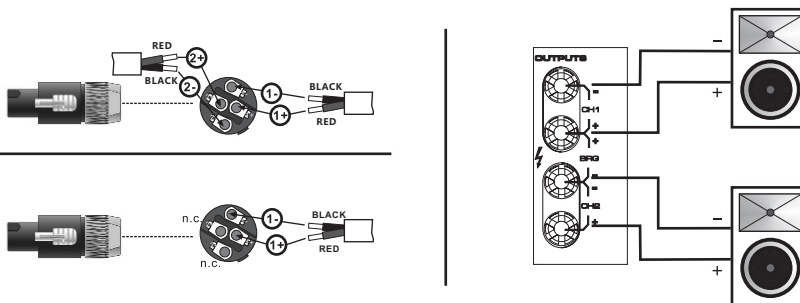
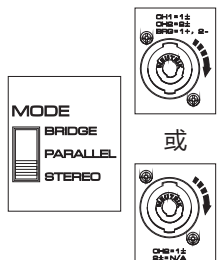

Remark : Inputs from CH1 and CH2 are effective.



1601 Jack Mckay Blvd, Ennis, Texas 75119, USA
Telephone: 800.876.3333 • Fax: 800.765.3435



Wiring and AC power supply

Power & Wiring distribution

The amplifier power supply isn't a non-resistance load and its use on unstable music signal, so it can not calculate with "Voltage x Ampere=Watt", the actual power consumption can not be fixed formula.

Referring to the power dissipation and power supply/AC of different product for wiring We suggest the users to match not less than the following wiring size specifications, to obtain the better comprehensive properties.

The Standard Voltage : 100-240V

Model	Dissipation Power	Cable size
MPA0802	480W	$\geq 1.5\text{mm}^2$
MPA1202	800W	$\geq 1.5\text{mm}^2$
MPA2402	1100W	$\geq 1.5\text{mm}^2$

When you use 1 power supply socket for many amplifiers, the power cable of the outlet should be bigger and also the internal cable of socket.



Please check the power voltage remark in the rear panel:
220V/240V = voltage range between AC200V to 240V.
Stable power supply voltage can ensure the amplifier works steadily.
The output power will be adjusted according to the difference voltage of power supply

More than one installation

When in the same AC power supply and its total power is more than 10kW, we suggest you use three phase and five wires in power distribution and the null wire can not use with Ground wire together.

Check after powered



For the first time powered, you have to use the multimeter to measure voltage, and confirm whether meet the requirements of the product. And do not connect signal and speaker after you confirm everything is ok, then power off the amplifier.

The importance of Ground wire



You should connect Ground for safety use.

If you don't have qualified Ground connection or not use the Ground, you may have a electricity shock. To avoid such thing happen, please connect Ground when you use.



Thermal Dissipation

Stack installation

To ensure the cooling environment, please meet the following condition

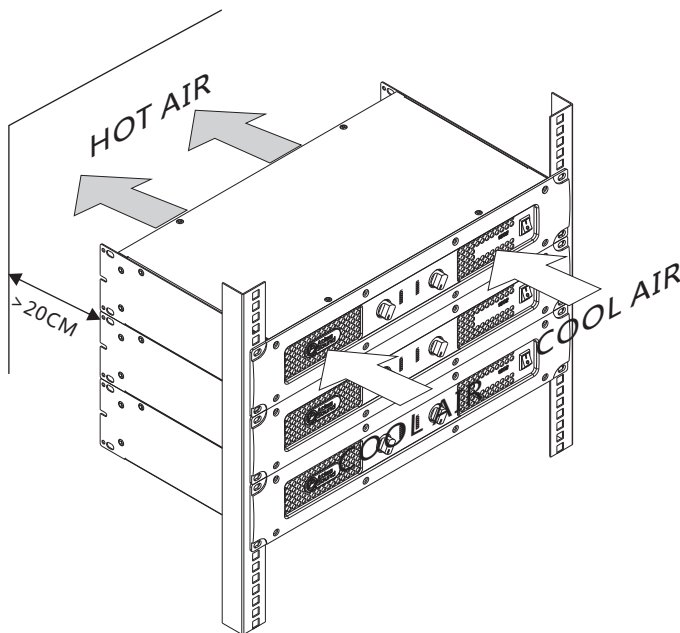

In order to have a good heat dissipation condition for amplifier, please clean the filter after you finish your install, because the dust in filter will stop the air vent, it's not good for the heat dissipation. And you should clean the filter net every month.



The ambient temperature should be lower than 35°C while running the amplifier

To avoid heat protection

To prevent the hot air back to front air vent

Install exhaust blower
take the hot air away

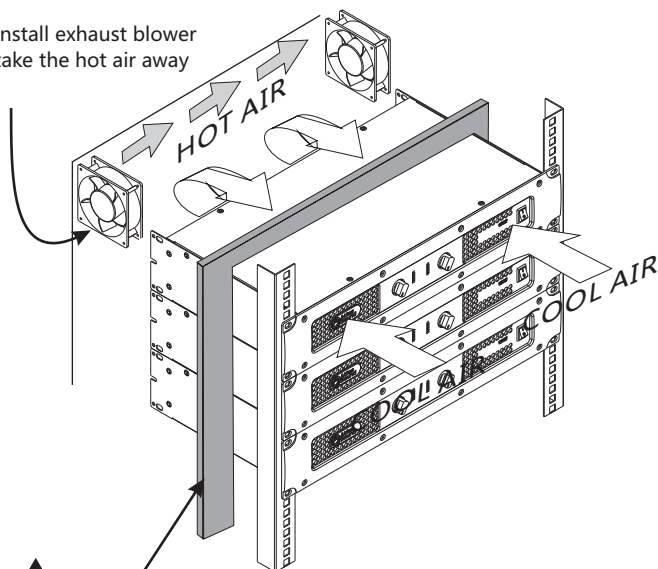

If use in Non-horizontal stack, we suggest the rear exhaust outlet up or straight to the vents of the room



Try your best to keep the temperature under 35°C even in extreme condition



Keep hot air will not flow back to the front air vent



1601 Jack Mckay Blvd, Ennis, Texas 75119, USA
Telephone: 800.876.3333 • Fax: 800.765.3435



Power Level adjustment

Procedure

Power On

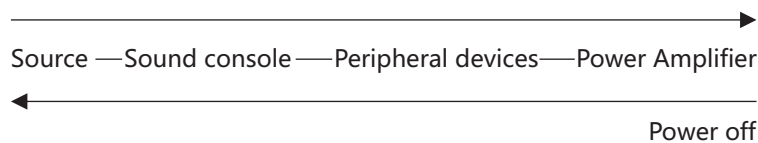

Power Level Adjustment

Power amplifier should be in the condition of no load in the following adjustment process:
Process :



For high power system, the Power-on order is very important, not in the order is likely to damage the equipment. Therefore we suggest that you use the sequence power device.



This is a normal step to adjustment, for more professional adjustment you should have a professional person to do that.

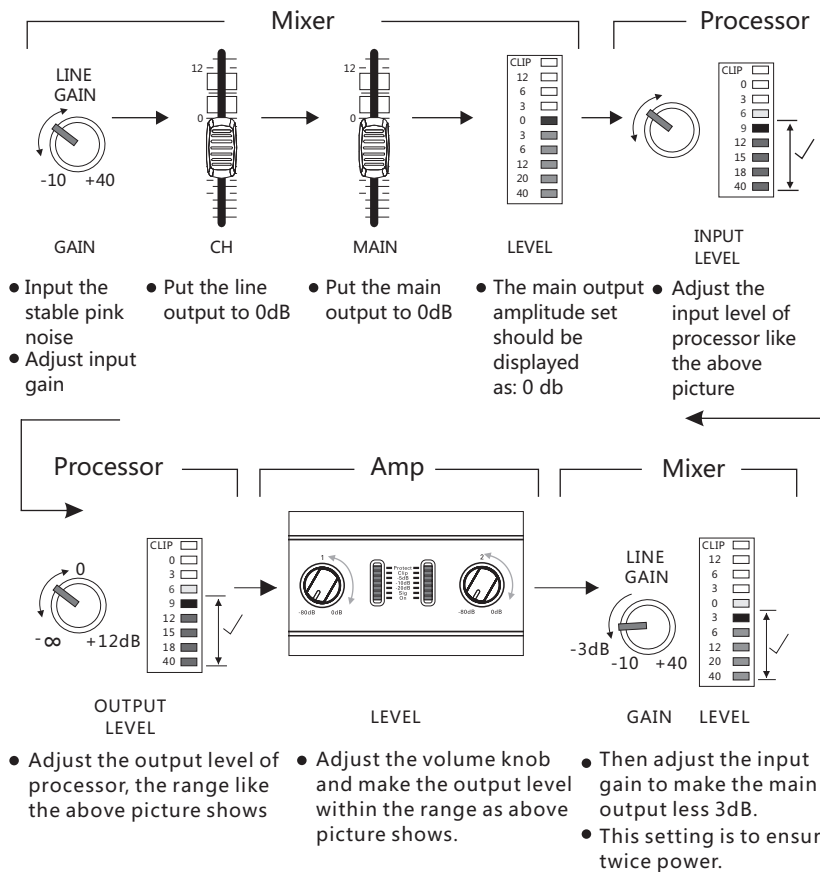

This step should operated by professional person, if you don't know how to do, please be careful!

Music Audition

Adjust the volume from very small to loud slowly, after you confirm the sound is normal then make it more louder. When the speaker output is close to its limit, the CLIP light will lights up and you should turn down your volume now, don't let the CLIP lights on long time, it means over load, may damage the system.



Specifications

Model	MPA0802	MPA1202	MPA2402
Output power			
8Ω stereo	300Wx2*	500Wx2*	700Wx2*
4Ω stereo	500Wx2**	850Wx2**	1250Wx2**
2Ω stereo	750Wx2**	1250Wx2**	1600Wx2**
8Ω bridge	1000W**	1700W**	2500W**
4Ω bridge	1500W**	2500W**	3200W**

Other Specifications

Frequency response	20Hz-20KHz(+0/-1dB)		
THD+N	≤0.09%	≤0.09%	≤0.09%
S/N rate	≥100dB	≥100dB	≥100dB
Damping factor	≥500	≥500	≥500
Slew rate	≥10V/μs	≥10V/μs	≥10V/μs
Input sensitivity	0.775/1.0V/32dB		
Input impedance(bal/unbal)	20kΩ/10kΩ		
Voltage gain (8 ohm)	36dB	38.2dB	39.7dB
Output circuitry	Class D	Class D	Class D
Cooling	Air flow from front to rear		
Protection	Soft start, VHF, DC, short circuit, over load, clip limit, over heat, progressive volume		

Connection

Input	Balance input XLR-F, Balance output XLR-M
Output	Two red and black Binding posts, NI4 SPEAKON

Function

Front panel	Front panel indicator: Working indicator, Signal/Clip/Protection/Power on/-5db/-10db/-20db / volume control knob
Rear panel	Sensitivity selection switch、 stereo/parallel/bridge/Cross-over selection switch

Dimensions/Weight

Product Dimension(mm)	483x305.5x89	483x305.5x89	483x305.5x89
Packaging Dimension(mm)	560x420x170	560x420x170	560x420x170
G.W.	7.8kg	8.1kg	8.5kg
Power Supply	13A Power Cord		

Remark : 1、*,The power is tested under the condition of 40ms burst,1kHz sine wave and 1% THD
2、**,The power is tested under the condition of 20ms burst,1kHz sine wave and 1% THD



1601 Jack Mckay Blvd, Ennis, Texas 75119, USA
Telephone: 800.876.3333 • Fax: 800.765.3435



Troubleshooting

After powered without any response

Measure the outlet with a multimeter to check if there is power available and when no multimeter, you can have a test pencil. If the power supply is normal and the amplifier still no response when powered then there is something wrong with the amplifier, need professional person to check it.

No signal output

1. First check if the signal input is right.

⚠ Check the connect of XLR, if the 2 and 3 reverted or the ground is reliable. Different circuitry design will have different connect way of the XLR, please follow the 2+、3- to soldering. **It can not be judged by comparing with other amplifiers (including other amplifiers in the same factory).**

2. The signal light don't lights up

If all the signal input is fine and the signal light don't lights up then may the amplifier has failure, you need to ask the professional person to check it.

3. Signal input normal but no sound

The signal light will flash with the change of input Volume, but now sound out, then you can check the connect of speakon if it is connect good and the wires are connect right (some times the problem of the wires connect, check its ± 1 and ± 2 connect), after the check above if still no sound out, please change a speaker cable and check again. Because some times also caused by the bad quality of the Speakon connector problem of the amplifier.

⚠ Through experiences, it may caused by the bad connection of some plugs and the socket.

Output sound distortion

1. After check the signal and loudspeaker they are fine and still can hear distortion when small sound, then may the amplifier has failure, need professional person to check it.

2. Some frequency band has distortion

First, check if the loudspeaker already overload, normally judge it in 95~105dB for higher SPL we don't comment here. Here we just think about the failure recovery of the amplifier. If in the middle have some rupture sound and more smaller volume more obvious, then it should be crossover distortion of the amplifier and this kind of distortion is easy to confuse with the failure of loudspeaker itself. If the amplifier have problem then you should send back to the manufacture for repair.

3. Distortion is High SPL

If the sound is normal when small volume and then you need to check the limit SPL of the loudspeaker. You can listen it in suitable volume and if clip light works, then you need reduce the output. Both loudspeaker and amplifier have limit, you should use them in their limit if in very high SPL they have distortion you should take care of them and reduce the output to the right position.

The protection light blinks

When the PROT light works, the amplifier into the protection mode.

1. Maybe the temperature is too high or output short or near short and they are not failure they can recovery after you can use it normally. But over heat will take more time to recovery. Also when over heat happened you should check the fan and the temperature of the install environment, if does you should solve the problem then can use amplifier. If you think the speaker was short, you can with a multimeter to check if the resist is lower than 2 ohm or 1 ohm with DC (Please calibrate the multimeter to measure for accuracy because of the small resistance).

2. If the PROT light always light up then it should be the problem of amplifier, you should send it back to professional person for repair.

Hum in the system

1. Hum exists even when there is no signal

Please keep the amplifier away from earth wire of power supply cables, just connect the fire wire and zero wire, no ground wire. If the hum is still existing, it can be judged that there are some problems in the amplifier. Please get in touch with professionals.

2. Hum exists when the system is completely connected
This is caused by the different ground voltages in difference devices in the system, mainly happens when the power supply is under three-phase distribution condition, each device is connected to different phase. This is not caused by amplifier.

Solution experiences, just for reference

- Combining the electricity, the power distribution box using the same one for all if possible.
- Make sure the grounding wire potential is zero and force the different grounding wire to the same level, if the grounding wire itself charged, indicates that the wire may be connected with the zero line. Please solve this problem.
- If unavailable above, then only to disconnect the ground wires of all devices, which helps to reduce the AC. But this is not meet the safe use of electricity, users must know what will happen if to do in this way. We do not recommend the floating use.

The amplifier is required maintenance in the condition below:

- If the amplifier smokes or smells burning.
- If the cabinet has severe indentation and deformation
- If the amplifier are dipped into the water
- If the internal components loosen
- If AC breaker skips out when current increases.





Limited Warranty

All products manufactured by Atlas Sound are warranted to the original dealer/installer, industrial or commercial purchaser to be free from defects in material and workmanship and to be in compliance with our published specifications, if any. This warranty shall extend from the date of purchase for a period of three years on all Atlas Sound products, including SOUNDOLIER brand, and ATLAS SOUND brand products except as follows: one year on electronics and control systems; one year on replacement parts; and one year on Musician Series stands and related accessories. Additionally, fuses and lamps carry no warranty. Atlas Sound will solely at its discretion, replace at no charge or repair free of charge defective parts or products when the product has been applied and used in accordance with our published operation and installation instructions. We will not be responsible for defects caused by improper storage, misuse (including failure to provide reasonable and necessary maintenance), accident, abnormal atmospheres, water immersion, lightning discharge, or malfunctions when products have been modified or operated in excess of rated power, altered, serviced or installed in other than a workman like manner. The original sales invoice should be retained as evidence of purchase under the terms of this warranty. All warranty returns must comply with our returns policy set forth below. When products returned to Atlas Sound do not qualify for repair or replacement under our warranty, repairs may be performed at prevailing costs for material and labor unless there is included with the returned product(s) a written request for an estimate of repair costs before any nonwarranty work is performed. In the event of replacement or upon completion of repairs, return shipment will be made with the transportation charges collect.

EXCEPT TO THE EXTENT THAT APPLICABLE LAW PREVENTS THE LIMITATION OF CONSEQUENTIAL DAMAGES FOR PERSONAL INJURY, ATLAS SOUND SHALL NOT BE LIABLE IN TORT OR CONTRACT FOR ANY DIRECT, CONSEQUENTIAL OR INCIDENTAL LOSS OR DAMAGE ARISING OUT OF THE INSTALLATION, USE OR INABILITY TO USE THE PRODUCTS. THE ABOVE WARRANTY IS IN LIEU OF ALL OTHER WARRANTIES INCLUDING BUT NOT LIMITED TO WARRANTIES OF MERCHANTABILITY AND FITNESS FOR A PARTICULAR PURPOSE.

Atlas Sound does not assume, or does it authorize any other person to assume or extend on its behalf, any other warranty, obligation, or liability. This warranty gives you specific legal rights and you may have other rights which vary from state to state.

Service

Should your HPA Series Multi-Impedance Amplifier require service, please contact the Atlas Sound warranty department at 1-877-689-8055, ext. 277 or support.atlassound.com to obtain an RA number.

Atlas Sound Tech Support can be reached at 1-800-876-3333 or support.atlassound.com.

Visit our website at www.AtlasSound.com to see other Atlas products.

©2015 Atlas Sound L.P. All rights reserved. Atlas Sound is a trademark of Atlas Sound L.P.
All other trademarks are the property of their respective owners. ATS006810 RevA 11/15



1601 Jack McKay Blvd, Ennis, Texas 75119, USA
Telephone: 800.876.3333 • Fax: 800.765.3435